



# POLYWOOD<sup>®</sup>

WINDOWS & DOORS SINCE 1992



## PREMIUM uPVC DOOR & WINDOW SOLUTIONS

Upgrade your home & workplace with our quality range of premium uPVC doors & windows and make it more secured, weather & sound proof and aesthetically enhanced !

# FEATURES

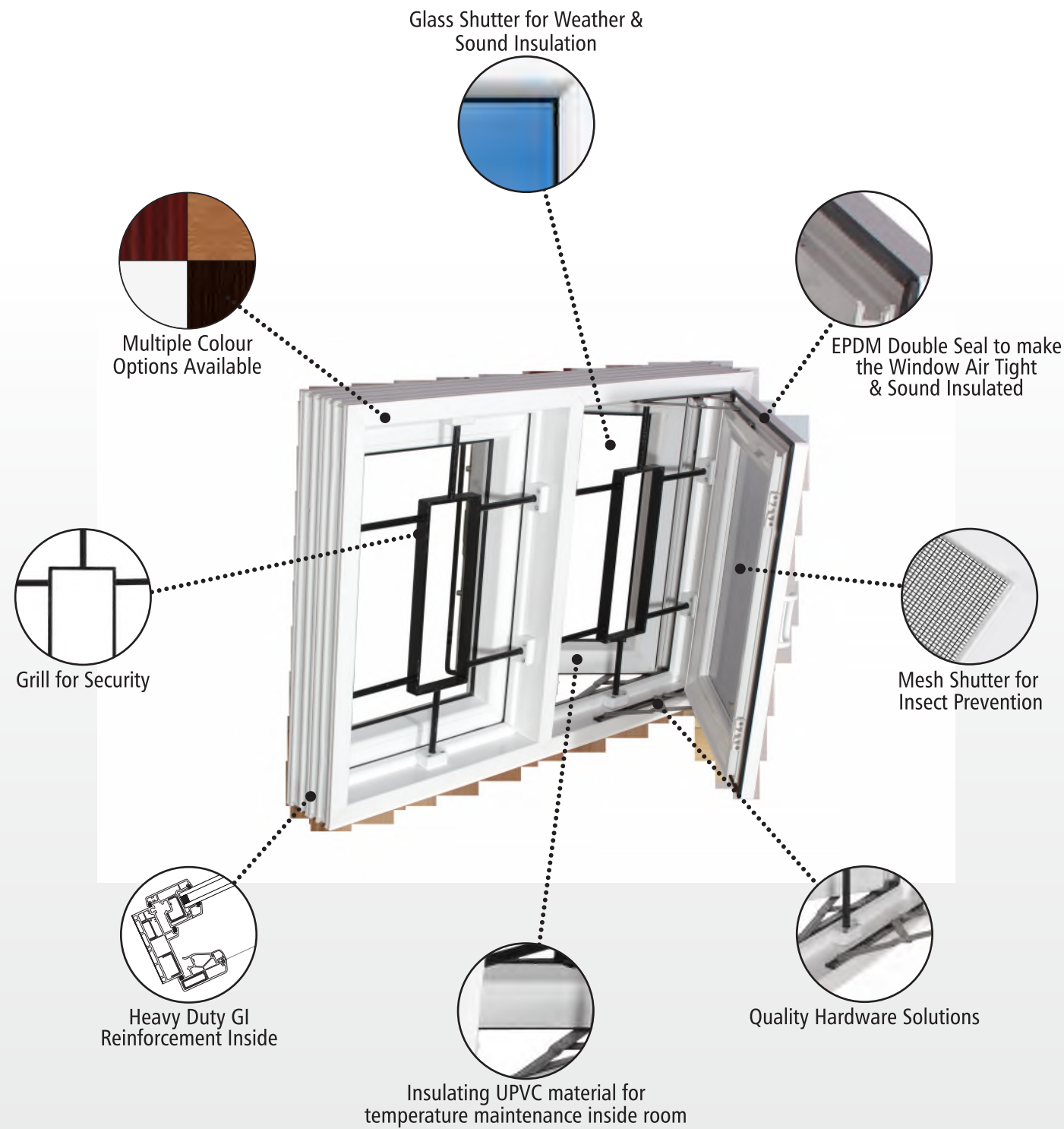

- ECO FRIENDLY
- EASY TO INSTALL
- FIRE RETARDANT
- WATER PROOF
- SOUND INSULATION
- ENERGY SAVER
- THERMAL INSULATION
- MAINTENANCE FREE
- TERMITE PROOF

# VILLA WINDOW

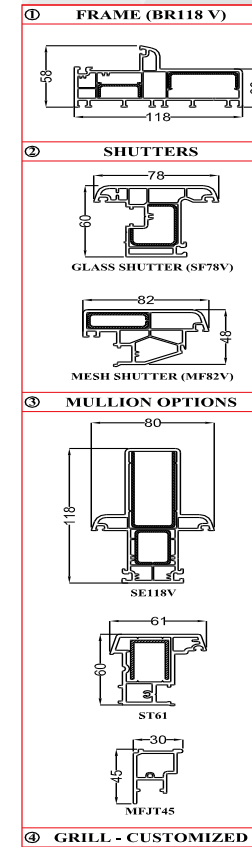

Cross Section

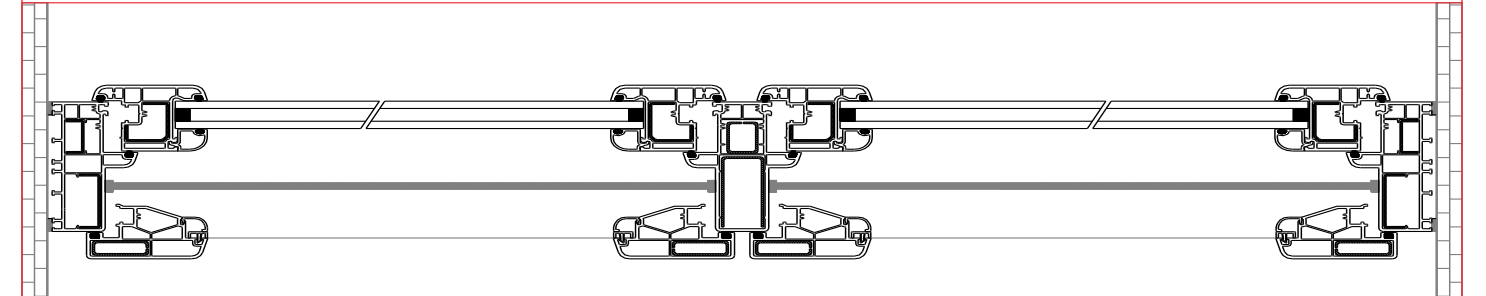

## General Configurations

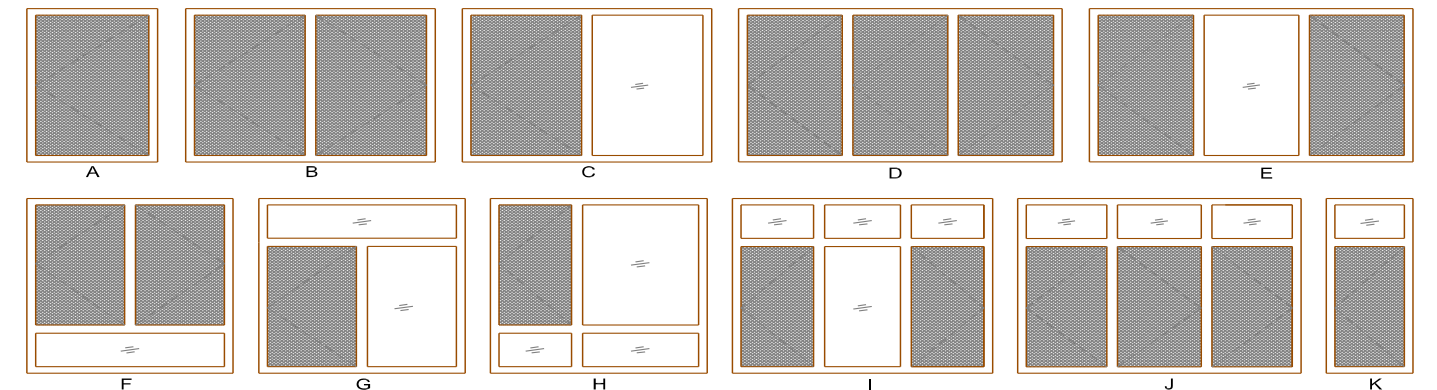

## Multiple Hardware Options

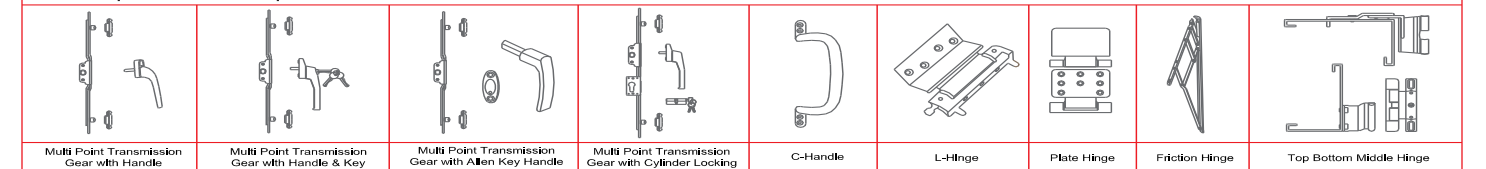



# CASEMENT WINDOWS

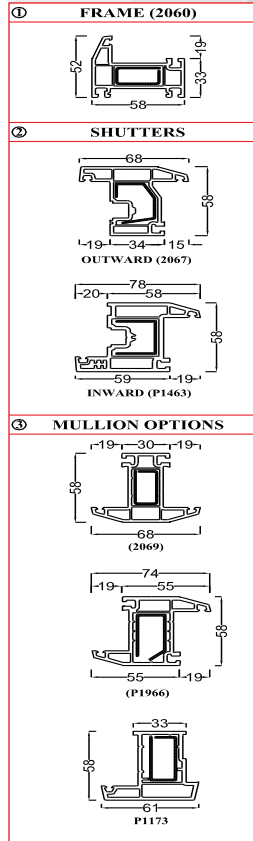

Cross Section

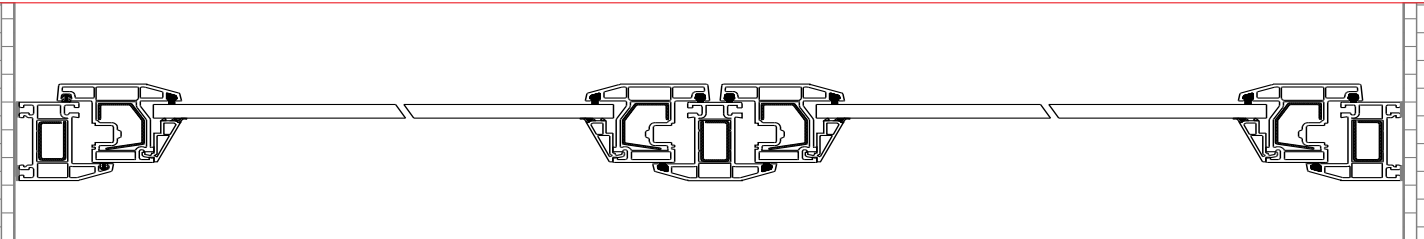

General Configurations

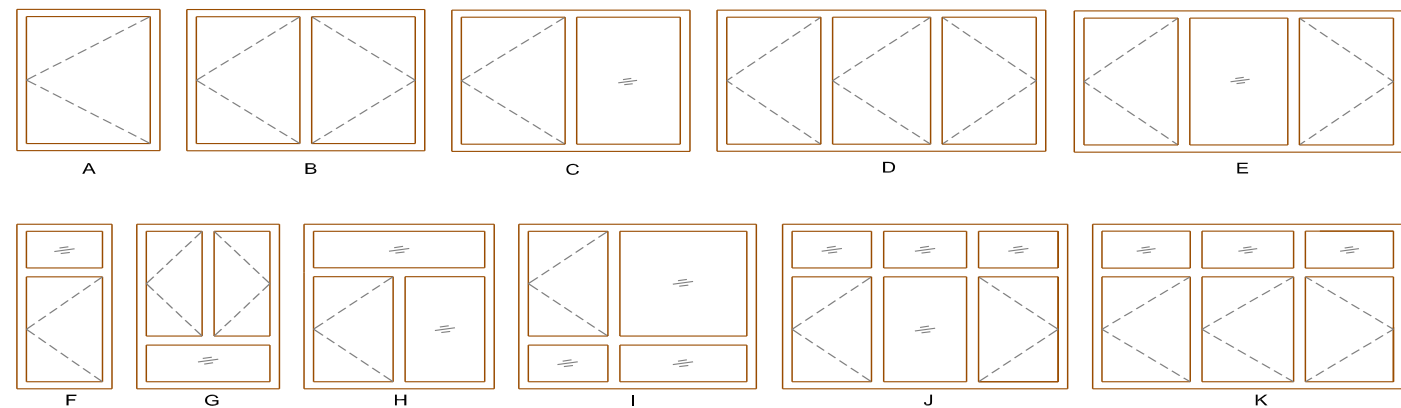

Multiple Hardware Options

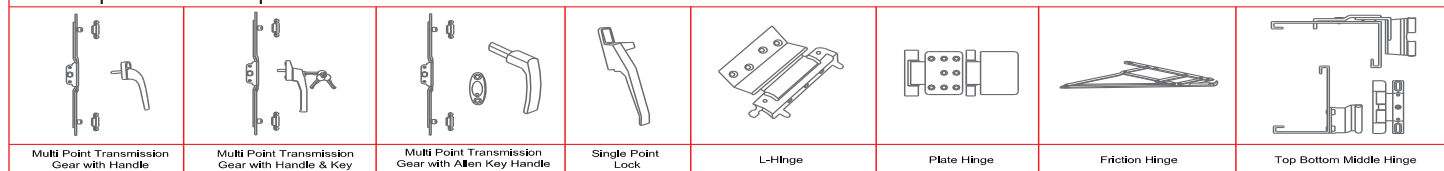

# SLIDING WINDOWS

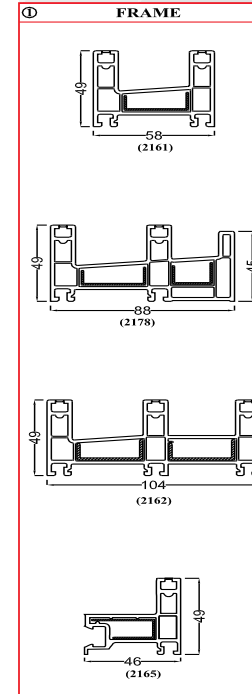

Cross Section

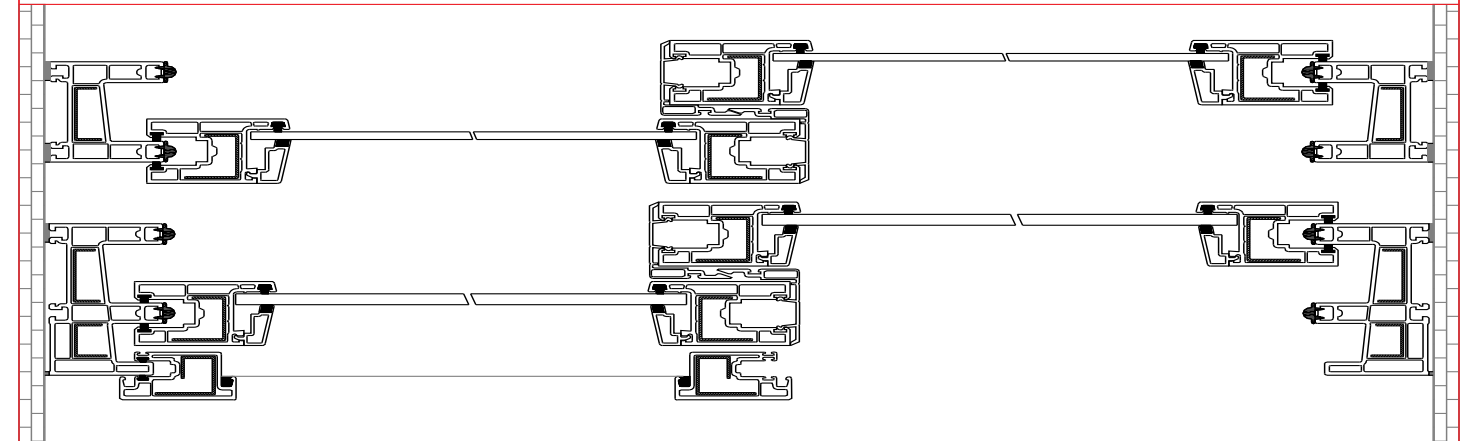

General Configurations

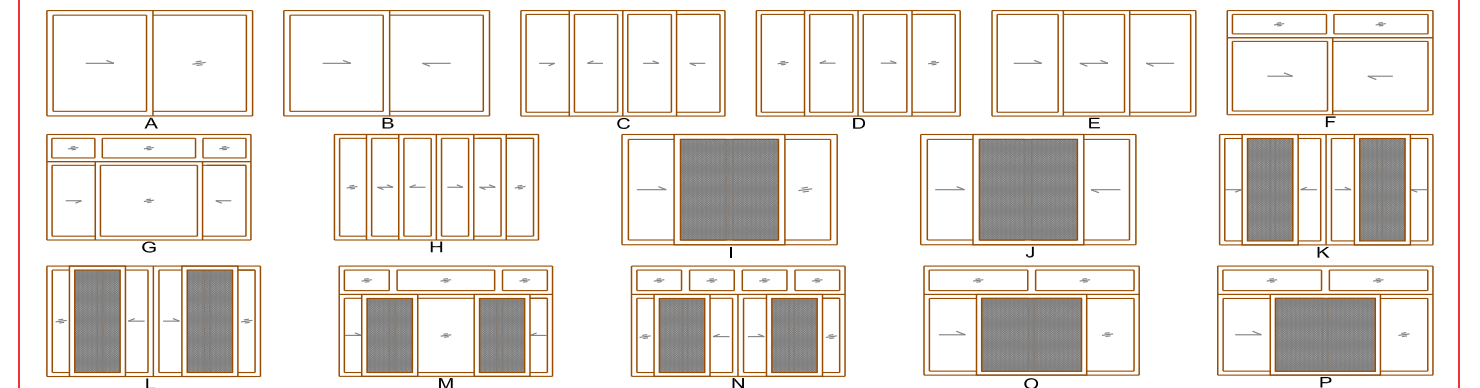

Multiple Hardware Options

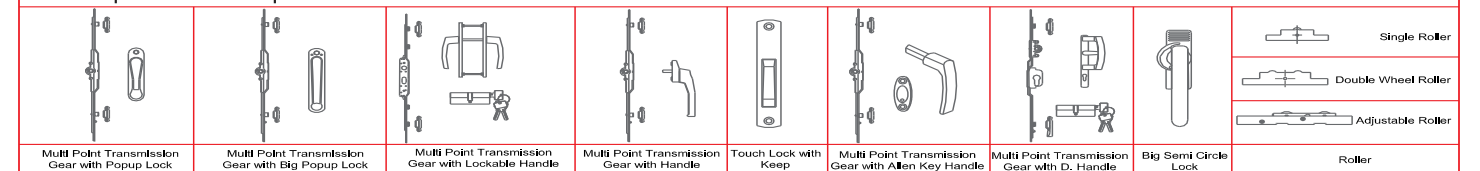



# SLIDING DOORS

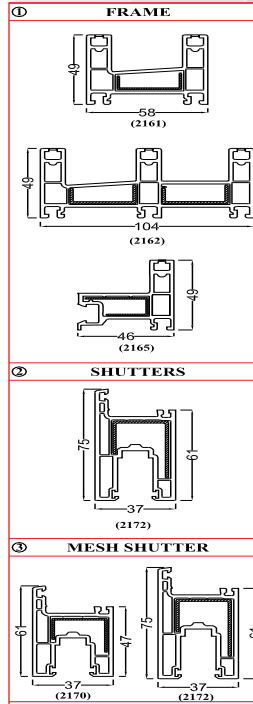

Cross Section

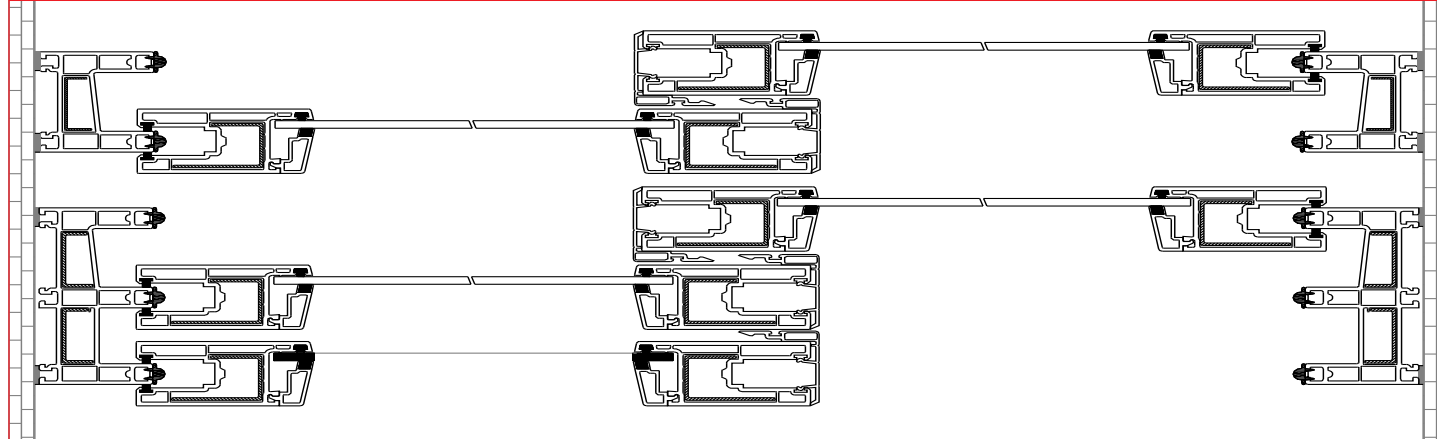

General Configurations

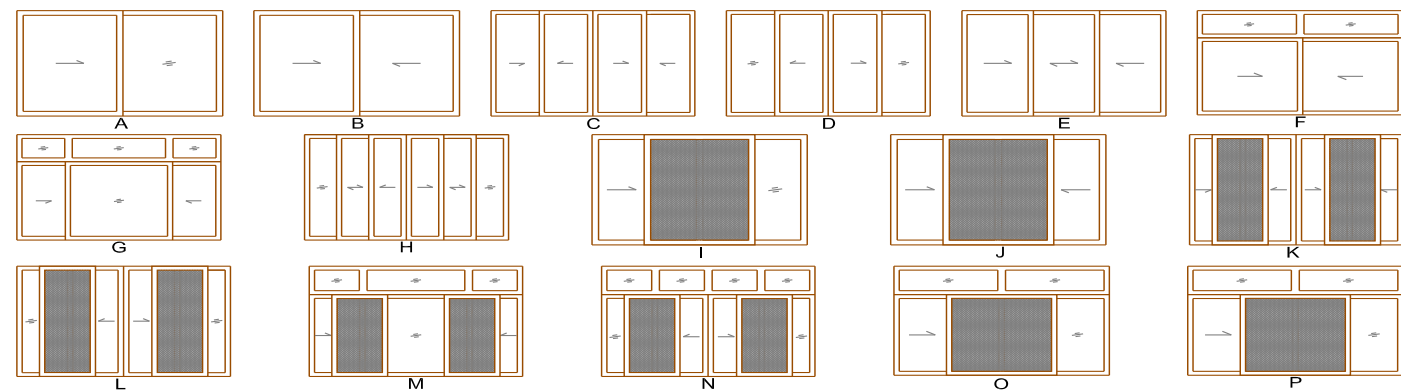

Multiple Hardware Options

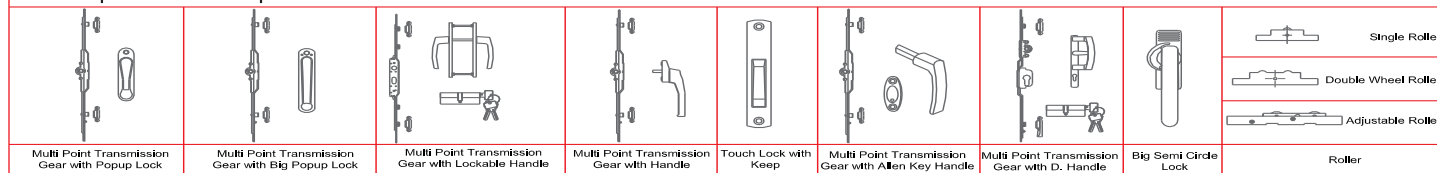

# HEAVY DUTY SLIDING DOORS

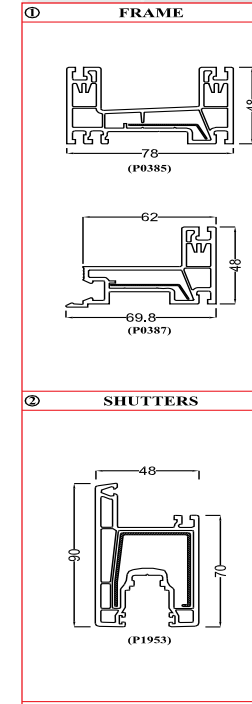

Cross Section

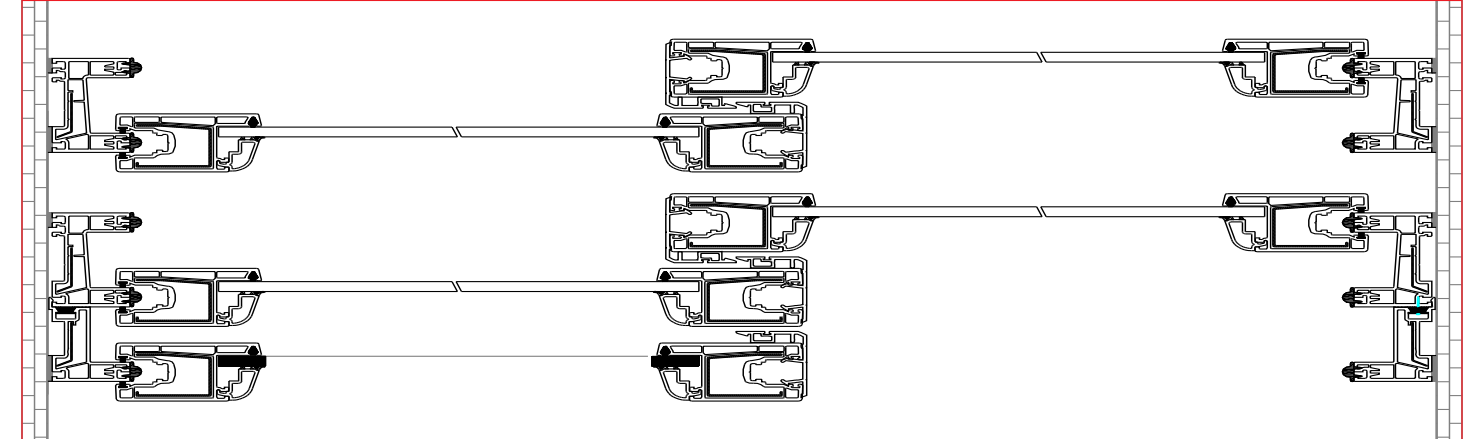

General Configurations

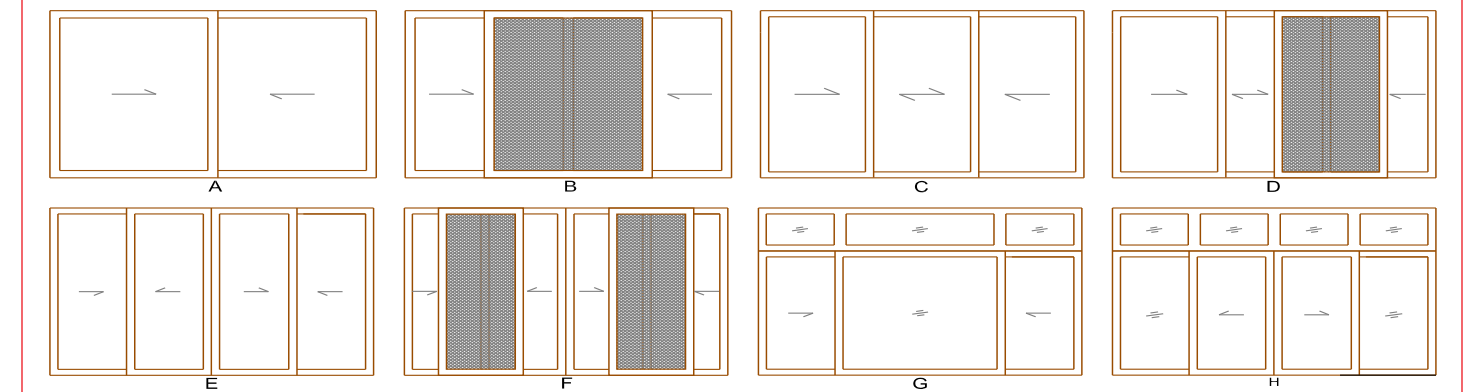

Multiple Hardware Options

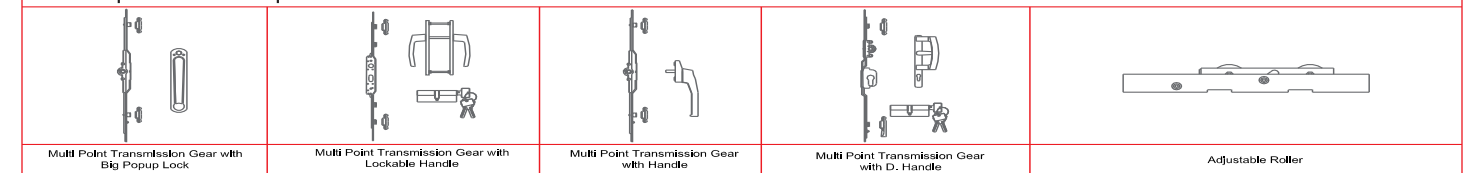



# CASEMENT DOORS

① **FRAME (P1963)**

② **SHUTTERS**

OUTWARD (2059)

③ **MULLION OPTIONS**

(2069)

(P1966)

P1173



Cross Section

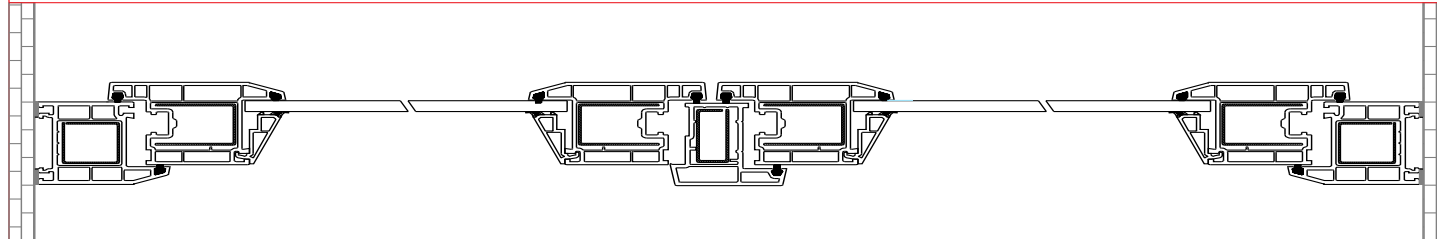

## General Configurations

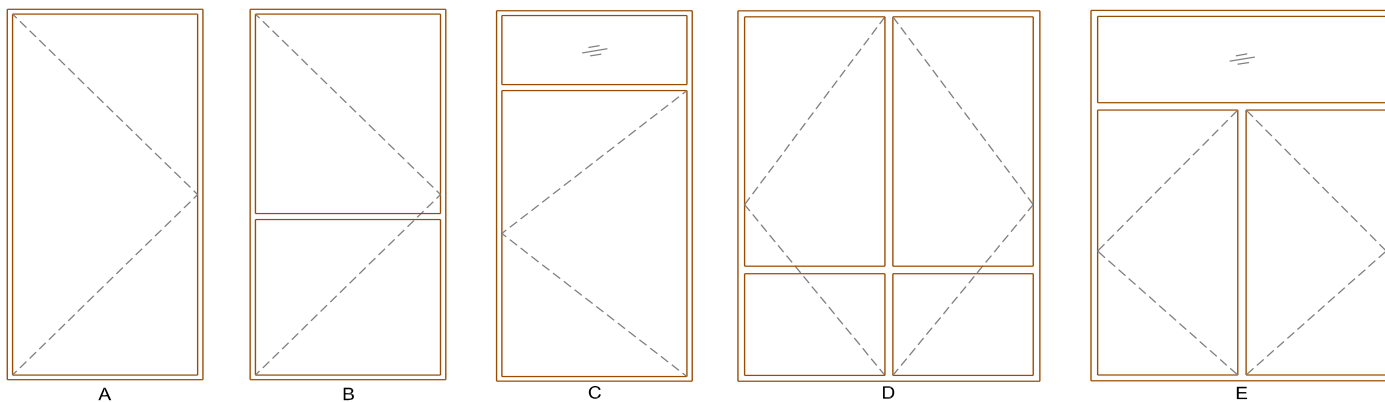

## Multiple Hardware Options

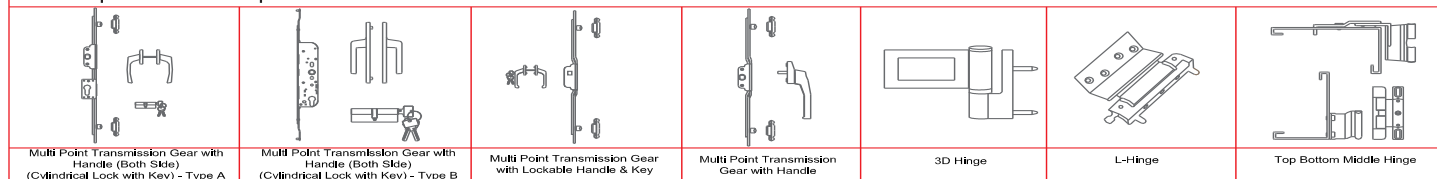

# VENTILATORS & FIXED WINDOWS

① **FRAME (2060)**

② **SHUTTERS**

OUTWARD (2067)

INWARD (P1463)

③ **MULLION OPTIONS**

(2069)

(P1966)



Cross Section

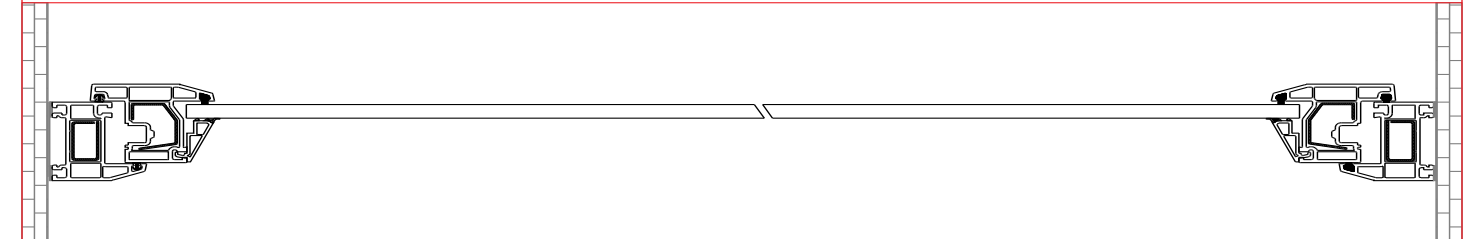

## General Configurations

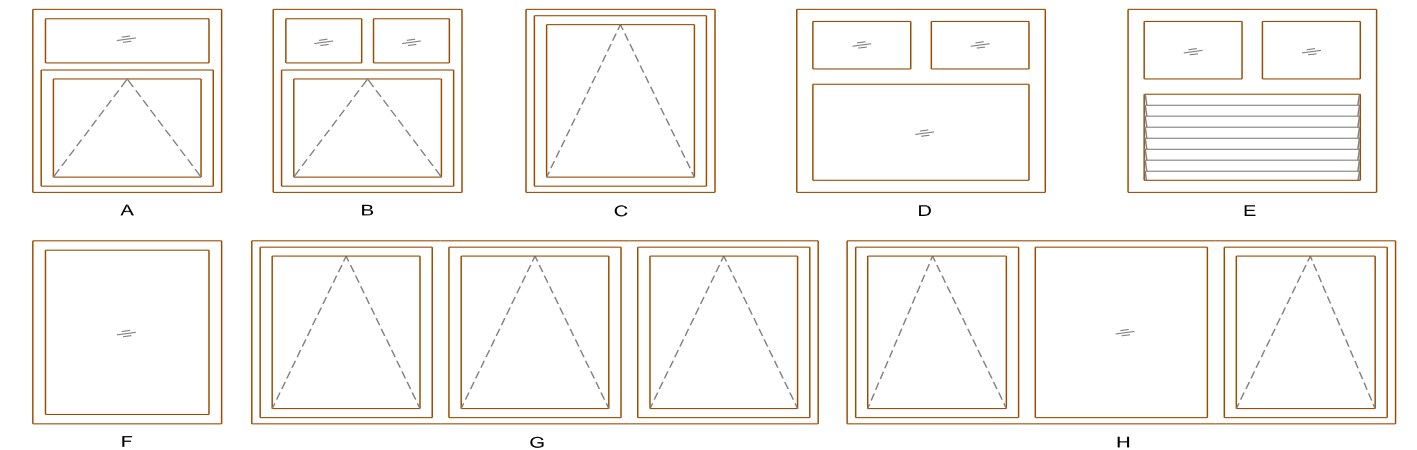

## Multiple Hardware Options

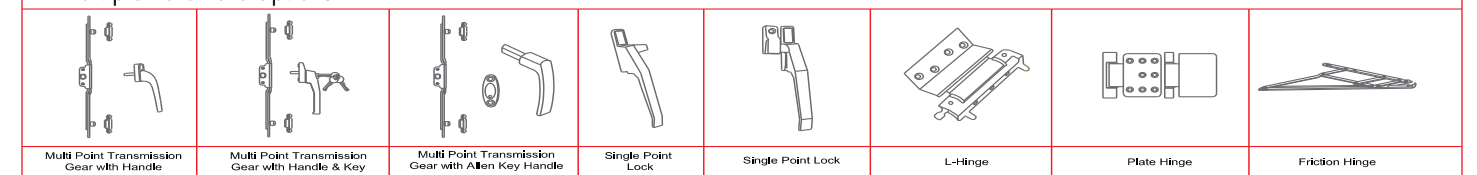



# DESIGNER WINDOWS

① **FRAME (2060)**

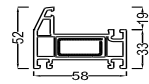

② **SHUTTERS**

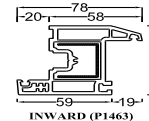
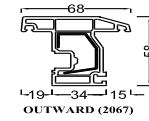

③ **MULLION OPTIONS**

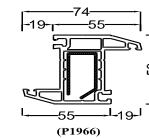
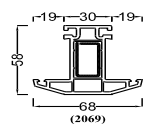

Cross Section

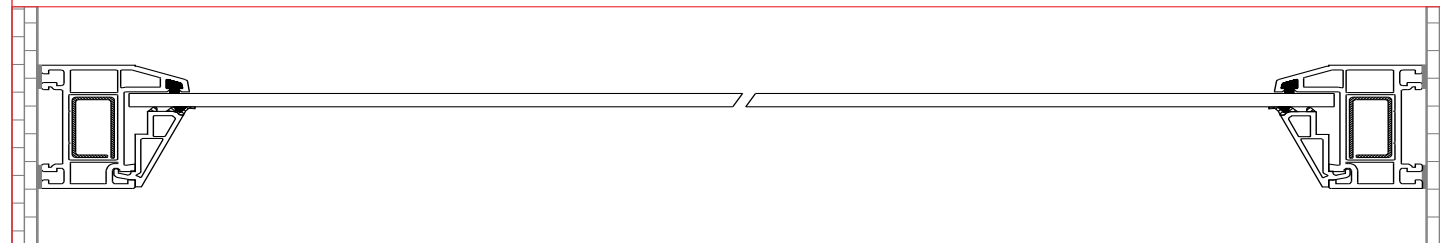

General Configurations

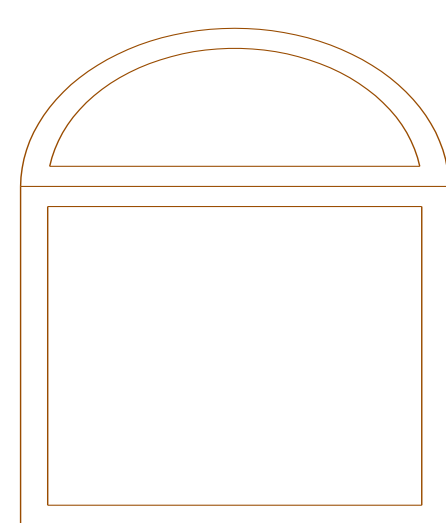

A

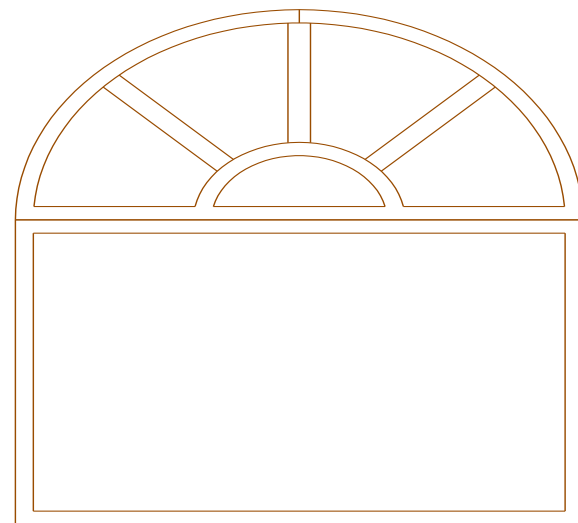

B

# WINDOWS COLOR OPTIONS



## MESH OPTIONS

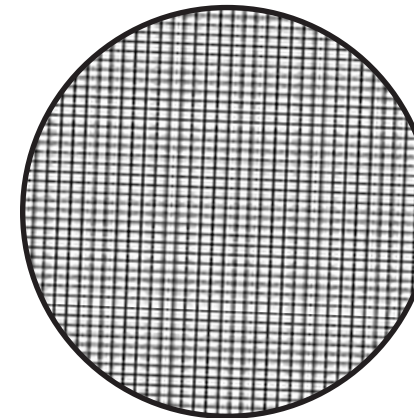

Stainless Steel Mesh

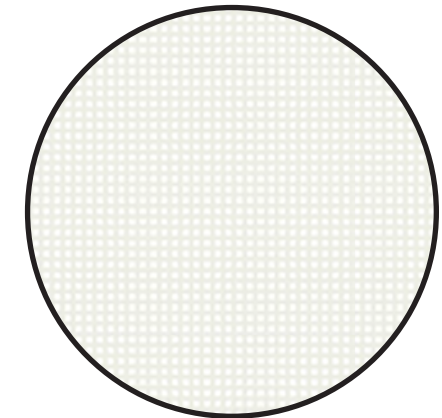

Fiber Mesh

## HARDWARE OPTIONS



## HARDWARE COLOR OPTIONS

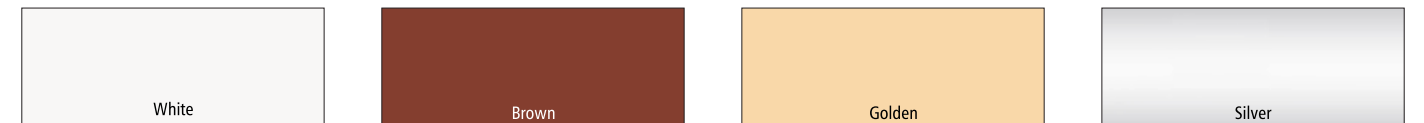

White

Brown

Golden

Silver



# A GLIMPSE OF OUR SERVICES TO OUR ESTEEMED CLIENTS



Commander Court, Chennai  
(by DLF - L&T)



Palm Drive, Gurgaon  
(by Emaar MGF)



Marbella, Gurgaon  
(by Emaar MGF)



Aura, Gurgaon  
(by Mahindra Lifespace)



**DHABRIYA  
GROUP**

## **DHABRIYA POLYWOOD LIMITED**

B-9D(1), Malviya Industrial Area, Jaipur, Rajasthan-302017  
Ph.: +91-141-4057171,(30Lines) 4040101- 05 | Email: inquiry@polywood.org

PLEASE LEAVE YOUR INQUIRIES, FEEDBACKS & COMMENTS **+91-74109 05000**  
( WHATSAPP ONLY )

[www.polywood.org](http://www.polywood.org)

### **Branch Offices**

- ♦ AHMEDABAD: +91-99989 66001-04
- ♦ COIMBATORE: +91-97906 00544 +91-93631 23236
- ♦ COCHIN: +91-87145 31551
- ♦ KOLKATA: +91-93310 58322 +91-89100 31829
- ♦ BANGALORE: +91-96112 22116 -117
- ♦ CHENNAI: +91-96112 22117 +91-97906 00544
- ♦ DELHI/NCR: +91-95605 40035 +91-95608 00500 , 72890 65350
- ♦ MUMBAI: +91-90791 32170 - 71 - 72